

# AMERICAN RANGE

QUALITY COOKING EQUIPMENT

## INSTALLATION MANUAL, USE AND CARE AND WARRANTY FOR VITESSE DROP-IN COOKTOPS



30"  
ARDCT-305



36"  
ARDCT-365



36"  
ARDCT-366

DESIGN



CLASS



FUNCTION



### ABOUT THIS MANUAL

**BEFORE USING YOUR APPLIANCE, PLEASE READ THIS MANUAL, PAYING SPECIAL ATTENTION TO THE IMPORTANT SAFETY INSTRUCTIONS LOCATED IN THE NEXT SEVERAL PAGES**

This manual is divided into several sections: *(Model numbers for Cuisine Burner Ranges page 13 and Performer Burner Ranges page 14)*

- 2 Important Safety Instructions** informs you about significant safety precautions when installing and operating your new appliance. **THIS IS A MUST READ SECTION OF THE MANUAL.**
- 7 Installation Section** describes how to unpack the unit, what to save and what to discard, installation dimensions, gas and electrical connections and how to identify the primary parts of the product so you can better understand what's going on "under the hood."
- 16 How to Operate Your Range Section** shows you how to light the burners, set the range for broil or bake and how to use convection to speed cooking times and improve the quality of your baked and roasted dishes.
- 20 Care and Cleaning** discusses how to keep your product in good operating condition, how to identify what might be going wrong with the unit, and how to communicate your observations with authorized field service technicians.
- 20 Troubleshooting** describes how to troubleshoot common issues.
- 21 Americana Model and Parts Identification** shows available parts for your range.
- 22 Warranty**



**RETAIN THIS MANUAL FOR FUTURE REFERENCE**

**! WARNING NEVER OPERATE THE TOP SURFACE COOKING SECTION OF THIS APPLIANCE UNATTENDED.**

» Failure to follow this warning statement could result in fire, explosion, or burn hazard that could cause property damage, personal injury or death.

» If a fire should occur, keep away from the appliance and immediately call your fire department.





**DO NOT ATTEMPT TO EXTINGUISH AN OIL/GREASE FIRE WITH WATER.**

1

DESIGNED & BUILT IN USA  
PROFESSIONAL COOKING EQUIPMENT

**AMERICAN RANGE**

# IMPORTANT SAFETY INSTRUCTIONS

	<b>FOR YOUR SAFETY!</b> Do not store or use gasoline or other flammable vapors or liquids in the vicinity of this or any other appliance.	
	<b>WARNING!</b> Improper installation, adjustment, alteration, service or maintenance can cause property damage, injury or death. Read the installation, operating and maintenance instructions thoroughly before installing or servicing this equipment.	

## **IMPORTANT – PLEASE READ AND FOLLOW!**

Instruction to be followed in the event the user smells gas must be posted in a prominent location.

This information must be obtained by consulting the local gas supplier.

- » Before beginning, please read all the instructions carefully.
- » **DO NOT** remove permanently affixed labels, warnings, or plates from product. This may void the warranty.
- » All local and national codes and ordinances must be observed, installation must conform with local codes.
- » The Installer must leave these instructions with the consumer who must retain for local inspector's use and for future reference.
- » Installation and service must be performed by a qualified installer, service agency or gas supplier.
- » Please ensure that the product is properly grounded.
- » In the Commonwealth of Massachusetts, installation must be performed by a licensed plumber or gas fitter.

Your safety and the safety of others is very important. We have provided many important safety messages in this manual and on your appliance. Always read and obey all safety messages.

 This is the SAFETY ALERT SYMBOL. This symbol alerts you to hazards which will result in severe injury or death.

 **DANGER** Hazards or unsafe practices which will result in severe personal injury or death.

 **WARNING** Hazards or unsafe practices which may result in severe personal injury or death.

 **CAUTION** Hazards or unsafe practices which may result in minor personal injury or property damage.

 **WARNING** **CA PROPOSITION 65:** The burning of gas cooking fuel generates some chemical by-products which are on the list of substances known by the State of California to cause cancer, birth defects and/or reproductive harm. To minimize exposure to these substances, always operate this unit according to the Owners Manual, ensuring to provide proper ventilation.

 **WARNING** This is a vented appliance. The appliance is not to be installed in conjunction with an air curtain, range hood, or ventilation systems which operates by blowing air downward towards the appliance. This type of ventilation system may cause ignition and combustion problems with the gas cooking appliance resulting in personal injury or unintended operation.

# IMPORTANT SAFETY INSTRUCTIONS

A ground fault interrupter (GFI) shall be used as required by NFPA-70 (*National Electric Code*), Federal / State / Local laws or local ordinances.

- » The required use of a GFI is normally related to the location of the receptacle to its proximity to significant sources of water or moisture.
- » American Range will not warranty any problems resulting from GFI outlets which are not installed properly or do not meet the requirements below.

IF THE USE OF A GFI IS REQUIRED, it must be:

- » The receptacle type (*breaker type or portable type not recommended*).
- » Used with permanent wiring only (*temporary or portable wiring not recommended*).
- » On a dedicated circuit (*no other receptacles, switches or loads in the circuit*).
- » Connected to a standard breaker or appropriate size (*GFI breaker of the same size not recommended*).
- » Rated for class ( $5mA \pm 1mA$  trip current) as per UL 943 standard.
- » In good condition and free from any loose-fitting gaskets (*if applicable in outdoor situations*).
- » Protected from moisture (*water, steam, high humidity*) as much as reasonably possible.

## WARNING

To prevent possible damage to cabinets and cabinet finishes, use only materials that will not discolor or delaminate and will withstand temperatures up to 194°F (90°C). Heat resistant adhesive must be used if the product is to be installed in laminated cabinetry, check with your builder or cabinet supplier to make sure that the materials meet these requirements.

## WARNING

The use of cabinets for storage above the oven may result in potential fire or burn hazard.

## DANGER

To avoid risk of electrical shock, personal injury or death; verify your appliance has been properly grounded in accordance with local codes, or in absence of codes, with the National Electrical Code (NEC), ANSI/NFPA 70 latest edition, or in Canada, to Canadian electrical codes, CSA, C22.2.

## WARNING

Do not use the handle or oven door to lift the oven, remove pull down door before installation to ensure that it is not used to lift the unit. Make sure pins are inserted into hinges before removing door to prevent injury to hands and / or fingers. (*See installation instructions*)

## WARNING

The misuse of the oven door(s) (*e.g.; stepping, sitting, or leaning on them*) can result in hazard or injuries and damage to the product.

## WARNING

This appliance must not be used for space heating. This information is based on safety considerations.

## WARNING

MOVING HAZARD: To avoid risk of severe personal injury; this appliance requires two or more personnel while handling and moving. Use of moving device is recommended.

# IMPORTANT SAFETY INSTRUCTIONS

## WARNING

IF THE INFORMATION IN THIS MANUAL IS NOT FOLLOWED EXACTLY, A FIRE OR EXPLOSION MAY RESULT CAUSING DAMAGE, PERSONAL INJURY OR DEATH

INSTALLATION AND SERVICE MUST BE PERFORMED BY A CERTIFIED / LICENSED INSTALLER, SERVICE AGENCY OR THE GAS SUPPLIER

- » Do not store or use gasoline or other flammable vapors or liquids in the vicinity of this or any other appliance.
- » Please observe all local and national codes and ordinances.
- » Do not remove any permanent warning labels or plates from this product.
- » Please ensure that this product is electrically grounded.
- » Consumers must retain these instructions for local inspectors and for future use.

### WHAT TO DO IF YOU SMELL GAS

- » **Do not try to light any appliance**
- » **Do not touch any electrical switch**
- » **Do not use any phone in your building**
- » **Using a neighbor's phone, immediately call your gas company**
- » **Follow the gas supplier instructions**
- » **If you can not reach your gas supplier, call the Fire Department**

## PRECAUTIONS

### SHIPPING DAMAGE CLAIM PROCEDURE

The equipment is crafted and inspected carefully by skilled personnel before leaving the factory. The transportation company assumes full responsibility for the safe delivery upon acceptance of the equipment.

If you receive a damaged product, immediately contact your delivery company, your dealer, your builder or installer. Do not install or attempt to operate a damaged appliance.

1. Note on the freight bill or express delivery any visible loss or damage and have the note signed by the person making the delivery.
2. File claim for damages immediately regardless of the extent of damages.
3. For damage noticed after unpacking (*concealed loss or damage*), notify the transportation company immediately and file a "Concealed Damage" claim with them. This must be done within fifteen (15) days from the date that delivery is made to you. Retain the shipping container for inspection.

## CAUTION

Check your local building codes for proper installation methods. In the absence of local codes, this appliance must be installed in accordance with the National Fuel Gas Code No. Z223.1 current issue, and the National Electrical Code ANSI/NFPA No. 70 current issue, or the CAN – B149 Installation Codes for Gas Burning Appliances, and C22.1 Canadian Electrical Code Part 1.

The installation must conform with local codes, or in the absence of local codes, with the National Fuel Gas Code, ANSI Z223.1, including:

1. The appliance and its individual shutoff valve must be disconnected from the gas supply piping systems during any pressure testing of that system at test pressures in excess of .5 psig (3.45 KPa).
2. The appliance must be isolated from the gas supply piping system by closing its individual manual shutoff valve during any pressure testing of the gas supply piping system at test pressures equal to or less than .5 psig (3.45 Kpa).

Verify the type of gas supplied to the location, being sure that the appliance is connected to the type of gas for which it is certified. Models come from the factory certified for use with Natural Gas (NG) or Liquid Propane (LP) gas. Your product, shown on the rating label and the supplied gas type must be the same. Upon opening your product, the rating label can be located on the front panel. If it is a cooktop, the rating label can be found on the side panel underneath the left burner.

If connecting this appliance to propane gas, make certain the propane gas tank is equipped with its own high-pressure regulator – in addition to the pressure regulator supplied with this product when applicable. The maximum propane gas pressure to this appliance must not exceed 14.0 inches of water column (34.9 millibar) from the propane gas tank to the pressure regulator.

Your appliance must be installed by a qualified gas installation technician. Have the technician show you the exact location of the gas shut-off valve on the incoming gas line so you know how to turn off the gas if necessary.

# IMPORTANT SAFETY INSTRUCTIONS

## DANGER

Do not store items of interest to children above or near the appliance. Children, as well as adults, must never be allowed to sit, stand or climb on any part of the appliance. Serious personal injury may occur.

## WARNING

Always **DISCONNECT** the electrical plug from the wall outlet power source before servicing the unit. It is recommended that a dedicated electrical circuit be used for this appliance. Always turn gas shut-off valve to **OFF** position before servicing unit.

## CAUTION

For personal safety, this appliance must be connected to a properly grounded and polarized electrical power supply. If only a two-prong outlet is available, it is the customer's responsibility to have it replaced with a dedicated, grounded, three-prong electrical outlet by a licensed technician. The gas surface burner re-ignition system when applicable depends on a low resistance electrical ground connection for reliable operation.

- » Do not cut or remove the third (*ground*) prong from the power cord
- » Do not use an adapter plug
- » Do not use an extension cord
- » Do not use a power cord that is frayed or damaged

## DANGER

To avoid the possibility of explosion or fire, do not store or use combustible, flammable or explosive liquids (*such as gasoline*) or vapors inside or in the vicinity of this or any other appliance. Keep items that could explode, such as aerosol cans, away from the product. Do not store explosive or flammable materials in nearby cabinets or areas. When operating the oven or broiler, do not touch the surfaces of the ceramic tile broiler, the rack or rack supports, the walls of the oven or the inside surfaces of the oven door – interior surfaces become hot enough to cause burns. The heat deflector, which deflects heat away from the control panel, and the oven door sides will also be hot during use.

## WARNING

**POWER FAILURE WARNING:** Due to safety considerations and the possibility of personal injury, when applicable do not attempt to light or operate range burners, grills, griddles, the oven or broiler during a power failure. Safety systems which detect the presence of an ignition source and operate the gas safety valve do not function during a power failure. Be sure all gas valve knobs are turned to and remain in the **OFF** position during a power failure.

## WARNING

**The California Safe Drinking Water and Toxic Enforcement Act of 1986 (*Proposition 65*)** requires the Governor of California to publish a list of substances known to the State of California to cause cancer or reproductive harm, and requires businesses to warn customers of potential exposures to such substances. Users of this appliance are hereby warned that when the oven is operated, there may be some low-level exposure to some of the listed substances including carbon monoxide. Exposure to these substances can be minimized by properly venting the oven to the outdoors using approved overhead ventilation equipment or by opening the windows and/or doors in the room where the appliance is located. This appliance must not be operated without a properly sized and functional ventilation hood.

# IMPORTANT SAFETY INSTRUCTIONS

## WARNING

To reduce the risk of appliance shifting, it must be secured to the countertop with properly installed hold-down brackets.

## CAUTION

Purchase a kitchen fire extinguisher for your home and store it in close proximity to your appliance. Should an uncontrolled fire occur, never use water on grease fires. Never pick up a flaming pan. The oven door interior and exterior, especially the glass can get hot during operation. Do not touch the glass – use the door handle to open or close the range door.

The push-to-turn gas valve knobs on the appliance are designed to be child-safe, however, they are not a guarantee of operation. Children must not be left alone or unattended in the kitchen while the appliance is in use. Never leave the appliance unattended during use. Boil-overs may occur, causing spills which may ignite.

Never wear loose fitting or long sleeved apparel while cooking. Never wear garments made of flammable materials. Clothing may ignite or catch utensil handles. **DO NOT** drape towels or other items on door handles. These items could ignite and cause burns.

If your product is a range or oven **ALWAYS** place oven racks in the desired position before you start cooking and while the oven is cool. Always use dry and sturdy pot-holders to carefully slide the oven rack out to add or remove food.

If your product is a range or cooktop located near a window, be certain window curtains or other flammable objects do not blow over or near the range burners; the items could catch on fire.

If operating the surface burners, the flame must be adjusted to just cover the bottom of the pan or pot. Excessive high flame settings may cause scorching of the nearby counter-top surface, as well as the outside of the utensil and handles.

**ALWAYS** turn the appliance off at the end of cooking.

When dehydrating food items, periodically check during the process to ensure that they do not catch on fire.

If you are “flaming” liquor or other spirits under an exhaust, **TURN THE FAN OFF**. The draft from the fan could cause the flames to spread out of control.

Care must be exercised if your appliance is equipped with a high-shelf. During heavy or continuous use, this shelf may become hot. Do not place combustible materials or plastic items on the shelf.

Turn the knobs to the OFF position prior to removing them from the valve stems for cleaning.

## WARNING

**NEVER** use this appliance as a space heater to heat or warm the room. Doing so may result in carbon monoxide poisoning and overheating of the appliance. Do not use the range top or oven as a food or kitchen item storage area.

Never block or cover any slots, holes or passages located anywhere inside or outside the range. These structures are important to safe operation of the appliance and doing so may block airflow through the oven or cooktop possibly causing carbon monoxide poisoning or fire. Routinely keep all slots free of grease and other materials.

This appliance has been tested for safe performance using conventional cookware. **DO NOT USE** any device or accessory not specifically recommended in this guide. **DO NOT USE** pan or pan covers on surface units, grills or griddles. These devices can create serious safety hazards including personal injury, create performance problems and may damage the appliance. Do not store or use corrosive chemicals, vapors, flammables or non-food products in or near this appliance. It is specifically designed for use when heating or cooking food. The use of corrosive chemicals while heating or cleaning could result in personal injury or damage to the appliance.

# INSTALLATION

The location selected for the range must meet the following criteria. If any of these criteria are not met, select another location.

## SITE PREPARATION

- » The cooktop is zero-clearance safe against non-combustible surfaces
- » The maximum depth of overhead cabinets installed on either side of the hood is 13"
- » Any openings in the wall behind the range and in the floor under the range must be sealed

## ELECTRICAL CONNECTION

- » The cooktop must be electrically grounded in compliance with local codes or, in the absence of local codes, with the National Electrical Code, ANSI/NFPA70.
- » This cooktop requires a 120 volt supply to operate the ignition system. The supply cord provided on the range is equipped with a three-prong (grounding) plug for protection against electrical shock.
- » The electrical service in the building must be equipped with a properly grounded three-prong receptacle.
- » Do not cut or remove grounding prong from this plug.

## POWER REQUIREMENTS FOR THIS COOKTOP

- » 120 VAC, 60 Hz, single phase, 15 AMP Max

## GAS CONNECTION

- » Be certain the appliance being installed is correct for the gas service being provided. Refer to the appliance data plate for the gas supply requirements.

- » A manual gas shut-off valve must be remotely installed and easily accessible within the cabinet. The regulator inlet is for a 1/2 inch gas line. The appliance ships with a 1/2 inch regulator.
- » Use at least a 1/2" commercial flex hose to connect range to the gas supply (service line).
- » A manual gas shut-off valve must be installed, in easy access in front of the gas supply (service line) and ahead of the cooktop for safety and ease of maintenance.
- » All valves must be in the OFF position before connecting to the gas supply line.

## PRESSURE REGULATOR

- » The regulator packed with the cooktop is adjusted at the factory for 5" WC (natural gas) or 10" WC (L.P.) depending on the customer's request. Regulators must be used in the installation.
- » The regulator can withstand a maximum pressure of 1/2 PSIG (14" WC). If the line pressure is beyond this limit, a step-down regulator will be required.
- » Any adjustment to regulators must be made **ONLY BY QUALIFIED** service personnel with proper test equipment.

## GAS REQUIREMENTS

- » Ensure supplied gas matches the cooktop's gas type.
- » Natural gas connection is 1/2" N.P.T. minimum 1/2" diameter flex line.
- » Natural gas inlet pressure to measure 7" to 10" W.C.
- » Propane gas connection is 1/2" N.P.T. minimum 1/2" diameter flex line.
- » LP gas inlet pressure to measure 11" to 14" W.C.
- » A step-down regulator in addition to the regulator provided with the LP range is required at the LP (Propane) source to limit pressure to a maximum of 14" W.C.

CHECK THAT ALL GAS CONNECTIONS ARE PROPERLY SEALED WITH A SUITABLE GAS JOINT COMPOUND.

TEST ALL JOINTS WITH A SOAPY WATER SOLUTION BEFORE LIGHTING THE BURNERS.

1. Turn ON the manual gas valve at the inlet side of the gas supply line.
2. Check for gas leaks at the flexible coupling or gas connector fitting using a solution of one part soap and three parts water.
3. Sparingly spray or brush the soapy solution at the gas fittings; active bubbling indicates location of gas leak.
4. If a gas leak is detected turn off the manual gas valve at the inlet side of the gas line. Call your certified service technician.

- » Do not remove protective packaging until you are ready to perform the installation.
- » Caution – the appliance is heavy. Use extreme care when handling!
- » Any openings in the wall and in the floor behind or under the cooktop must be sealed.
- » Do not use an extension cord with this appliance. Such use may result in fire, electrical shock or other personal injury.



- » Installation of this appliance should be performed by qualified, licensed contractors.
- » To remove the packaging, first remove the staples located at the bottom perimeter of the corrugated cardboard cover.
- » Confirm access to adequate power and gas. See specifications and electrical requirements table.
- » Fill out the inside cover of this installation manual with the requested data. Model Number and Serial Number can be found on the plate located on the bottom of the chassis.

# INSTALLATION

## SAMPLE RATING PLATE

### RATING PLATE

The information on the rating plate defines the model, serial number, gas type (natural or liquid propane), operating pressures and burner BTU ratings. Keep this information for future reference. It is essential for proper identification of the unit when requesting additional information or factory support.

				p/n 11038	
QUALITY RESIDENTIAL COOKING EQUIPMENT 13592 DESMOND ST., PACOIMA, CA 91331 www.americanrange.com ANSI Z21.1b-2012/CSA 1.1 (R2006) "HOUSEHOLD COOKING APPLIANCES" "VENTED UNIT" TO BE USED IN CONJUNCTION WITH A SUITABLE VENT. SEE INSTALLATION INSTRUCTIONS					
3013256		GAS TYPE: NAT		MANIFOLD PRESSURE INCHES W.C.: 5.0	
MODEL NO: ARDCT365-N		SERIAL NO: XXXXXX-XXX			
LARGE: 21kBTU	MEDIUM: 18kBTU	SMALL: 13kBTU	GRIDDLE:		
VOLT: 120	AMPS: 1	OVEN 1:	BROILER 1:		
HZ: 60	PH: 1	OVEN 2:	BROILER 2:		
NOT TO BE INSTALLED IN CONJUNCTION WITH AIR CURTAIN, RANGE HOOD OR VENTILATION SYSTEMS WHICH OPERATE BY BLOWING AIR DOWNWARD TOWARDS THE APPLIANCE					
MODEL NO: ARDCT365-N		[Barcode]			
SERIAL NO: XXXXXX-XXX		[Barcode]			
MODEL NO: ARDCT365-N		[Barcode]			
SERIAL NO: XXXXXX-XXX		[Barcode]			

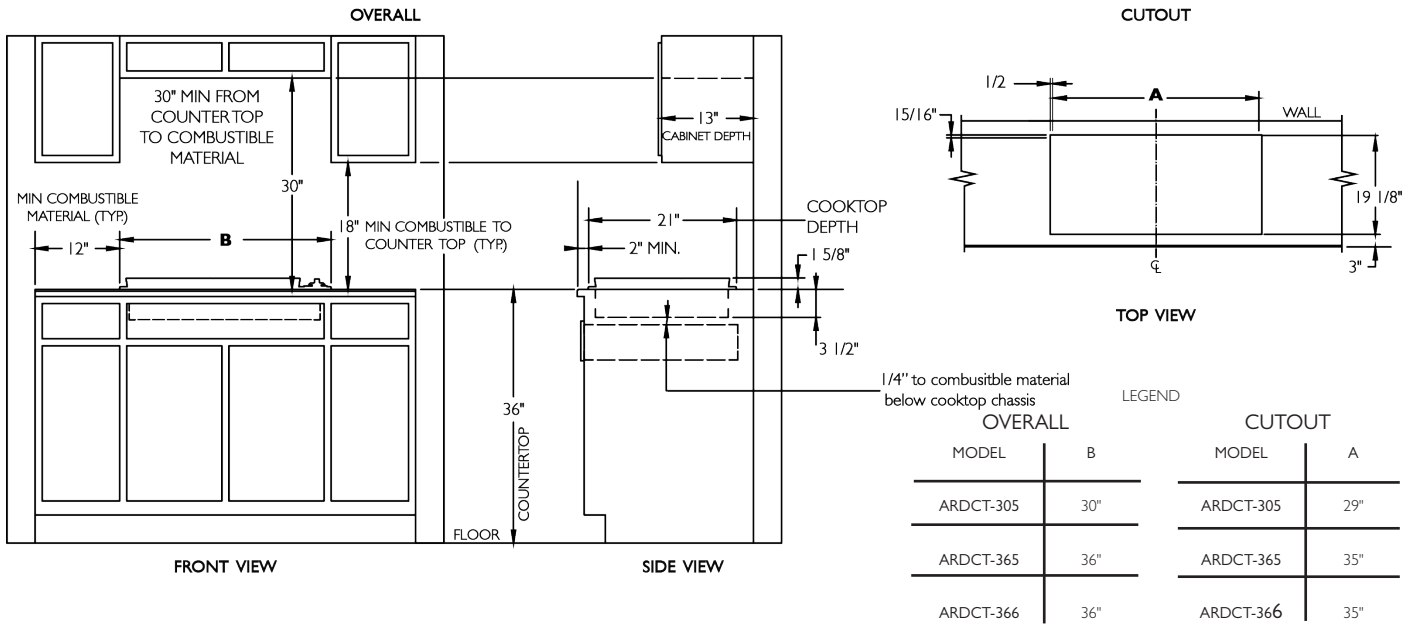

## VENT HOOD CLEARANCE DIMENSIONS

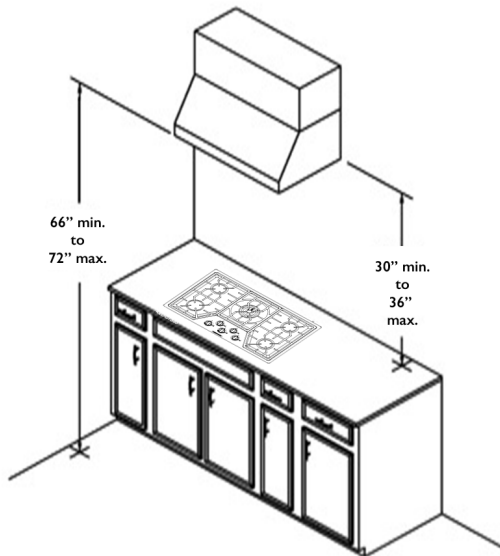

## VENT HOOD RECOMMENDATIONS

COOKTOP MODEL	WALL-MOUNT INSTALLATION	ISLAND INSTALLATION
	24" Deep x Unit Width	30" Deep x Unit Width
ARDCT-305	500-800 CFM	500-900 CFM
ARDCT-365	600-800 CFM	600-900 CFM
ARDCT-366	600-900 CFM	600-1000 CFM

## WARNING

This appliance should not be installed with an air curtain or other type of ventilation system that blows air downward toward the cooktop. Such type of ventilation system may cause ignition and combustion problems with the gas cooking appliance resulting in personal injury or unintended operation.



# INSTALLATION CHECKLIST

**REGISTRATION CARD  
TO VALIDATE YOUR WARRANTY,  
YOU MUST MAIL, EMAIL OR FAX THIS FORM WITH A COPY OF  
YOUR RECEIPT TO:**

AMERICAN RANGE CUSTOMER SERVICE,  
13592 DESMOND STREET, PACOIMA, CA 91331  
EMAIL: [info@americanrange.com](mailto:info@americanrange.com) FAX: 818.897.8839

**REGISTER ONLINE AT**

[www.americanrangehome.com/product-registration/](http://www.americanrangehome.com/product-registration/)



This checklist has been developed to assure proper installation of your appliance.

Model Number: _____ *	Installation Date: _____
Serial Number: _____ *	Installation Company: _____
Gas Type: _____ *	Installation Rep's Name: _____
Electrical Information: _____ *	Installer's Address: _____
Purchase Date: _____	Installer's Phone: _____
Dealer: _____	* As specified on appliance Rating Plate – see page 8 for reference.

## CHECK ALL THAT APPLY

### PRODUCT INSPECTION *(Appearance and Aesthetics)*

#### Inspect Packaging and Unit for Shipping Damage

- Packaging damage? Yes    No
- Unit damage? Yes    No

#### Inspect Unit for Manufacturing Defects

- All Packaging Removed? Yes    No
- Cooktop Defects? Yes    No
- Front Section Defects? Yes    No
- Side Panels Defects? Yes    No
- Grates Are Level and Do Not Rock? Yes    No

### INSTALLATION

- Installation Manual Read? Yes    No
- Safety Instructions Read? Yes    No
- Specified Clearances *(Including Cabinet-Surfaces Clearances)* were followed? Yes    No
- Unit Leveled, Front-to-Back and Side-to-Side? Yes    No
- Side-Trim Panels are 3/8" above the countertop? Yes    No
- Hold Down Bracket Installed? Yes    No
- Ventilation Requirements Followed? Yes    No
- Electrical Supply Properly Grounded? Yes    No
- Proper Polarity at receptacle? Yes    No
- Electrical Supply Adequate/Specified Input Voltage? Yes    No
- Power Cord Free From Damage? Yes    No
- No Extension Cord In Use? Yes    No
- GFCI Installed to specifications? Yes    No
- Gas Supply Line Sized Per Specifications? Yes    No
- A Manual Gas Shut-Off Valve is Installed According to Specifications? Yes    No
- Gas Supply Matches Unit Requirements? Yes    No
  - Natural Gas
  - Liquid Propane
- Gas Supply Pressure Does Not Exceed 14" W.C.? Yes    No
- Gas Pressure Verified? Yes    No
  - Natural Gas *(7" Water Column)*
  - Liquid Propane *(11" Water Column)*
- Gas Connections Tested and Verified to be Leak-Free? Yes    No

### INITIAL START-UP

#### Cooktop Ignition

- Cooktop Burners? Yes    No

#### Air Shutter Adjustment (if needed)

- Open-Burner Adjustment? Yes    No

### FUNCTIONAL VERIFICATION

- Valve Rotation Functions? Yes    No
- A Copy of This Manual Has Been Provided To The Owner of The Appliance? Yes    No

### INSPECTION and INSTALLATION NOTES:

---

---

---

---

---

---

---

---

---

---

---

---

---

---

---

---

---

---

---

---

---

---

---

---

# VITESSE MODEL AND PARTS IDENTIFICATION (Package Contents)

	PART DESCRIPTION	PART NO.	ARDCT-305	ARDCT-365	ARDCT-366
1	Knob, Blk/Chrome Dual	R32090	1		2
2	Knob, Blk/Chrome Sgl	R32091	4		4
	Knob, Blk/Chrome Dual, Front	R32092		2	
	Knob, Blk/Chrome, Sgl, Rear	R32093		1	
	Knob, Blk/Chrome, Sgl, Rear	R32094		2	
	GRATE, ARDCT				
	Grate, Side (not shown)	R17593	2	-	-
	Grate, Left (not shown)	R17596	-	1	-
	Grate, Right (not shown)	R17597	-	1	-
3	Grate, Side	R17594	-	-	2
	Grate, Center (not shown)	R17598	-	1	-
3	Grate, Center	R17595	-	-	1
	SINGLE BURNER				
4	Burner Caps	R16403	4	3	4
5	Burner Head	R16404	4	3	4
	FIXED TOWER BURNER				
6	Burner Caps, Front Left	R16407	-	1	1
	DUAL BURNER				
7	Base, Dual Burner Inner	R16419	1	1	1
8	Head, Dual Burner Outer Black	R16424	1	1	1
9	Base, Dual Burner Cross Ring	R16417	1	1	1
10	Beauty Ring, Dual Burner Black	R16425	1	1	1
	Regulator, NG (not shown)	R80022	1 (NG)	1 (NG)	1 (NG)
	Regulator, LP (not shown)	R80023	1 (LP)	1 (LP)	1 (LP)
12	Bracket, Anchor	9148	2	2	2
	Bracket, Anchor Screw	A42218	2	2	2
	Use and Care Manual (not shown)	R70004	1	1	1
	Registration Card (not shown)	R38006	1	1	1

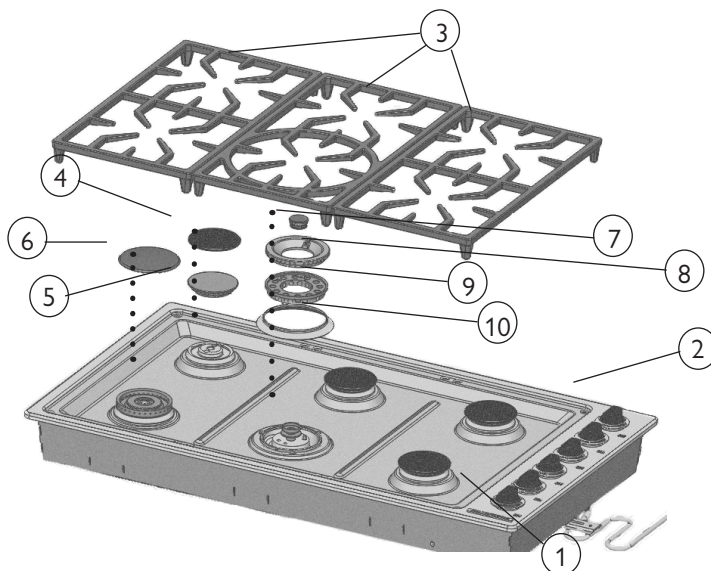

BOTTOM VIEW

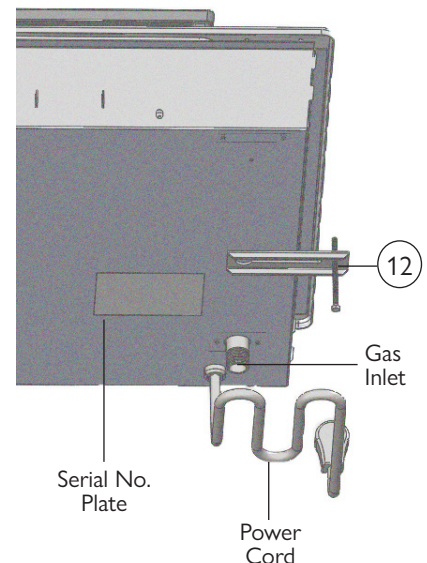

# BURNER AND KNOB IDENTIFICATION

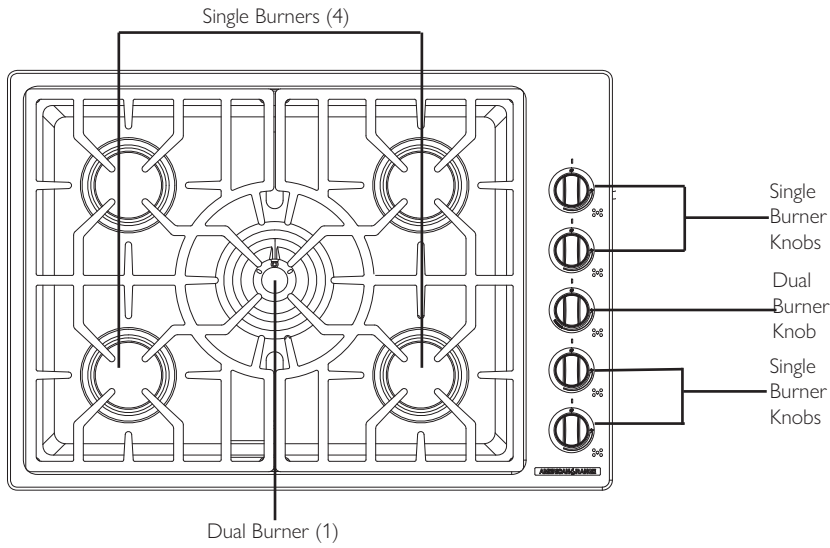

## ARDCT-305

1. Dual Burner Knob – with Simmer (1)
2. Single Burner Knobs (4)
3. Grates (2)

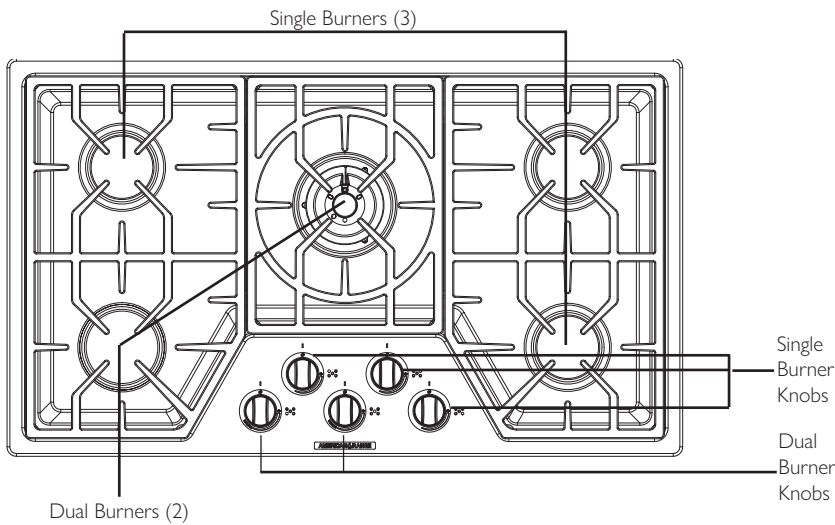
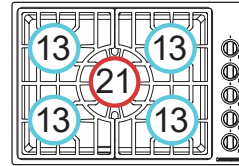

## ARDCT-365

1. Dual Burner Knobs – with Simmer (2)
2. Single Burner Knobs (3)
3. Grates (3)

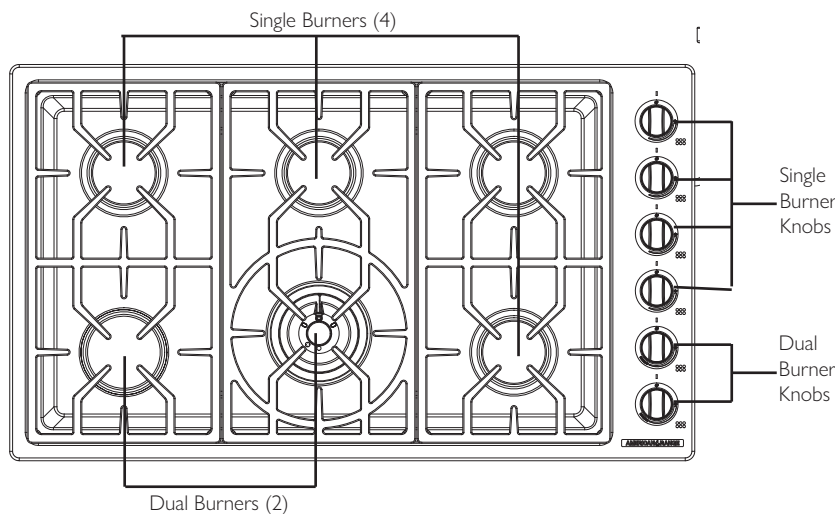
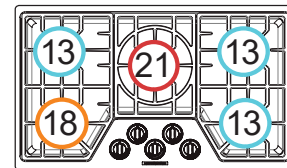

## ARDCT-366

1. Dual Burner Knobs – with Simmer (2)
2. Single Burner Knobs (4)
3. Grates (3)

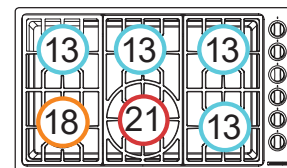

# OPERATING YOUR RANGE

## BEFORE USING THE NEW COOKTOP

- » Before using the cooktop for the first time, wash the outside area with soap and water to remove any shipping and factory residue.
- » The burner grates are designed in sections and are easy to remove and clean. They are made of cast iron with a porcelain coating and will remain hot after the burner is turned off creating a residual heat for continued cooking. Use caution when handling.
- » Your new professional Range is equipped with burners that are similar to those used in restaurants. The burner heads are large and designed to ensure even heat distribution for better cooking. They must be in place and properly seated before lighting.
- » The Range must not be operated without the burner heads.
- » There are no continuously burning pilot lights. An electronic spark ignition system is used to light the burner. If the flame should go out from a boil-over or a strong draft, the burner will automatically reignite.

## OPERATION OF THE BURNERS

1. Press in on the knob that corresponds to the burner that you would like to light. Use the front panel graphic to confirm your selection until you become familiar with the range. Turn the knob counter-clockwise to the "American Flame" icon located on the knob – this is the light position of the burner valve.
2. The igniter for all the surface burners will begin sparking – however, gas will flow to only the selected burner.
3. After the burner lights, the igniter clicking will stop – indicating that the flame sensing and re-ignition system is active on the selected burner.
4. Rotate the knob to any flame setting that you desire between MAX and SIMMER.

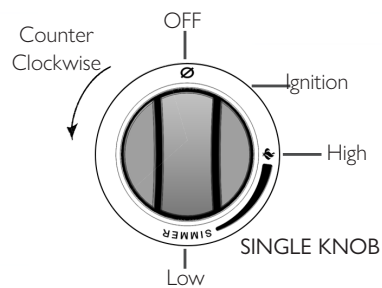

BURNER TYPE	SMALL	MEDIUM	LARGE
Sealed Burners	13,000 BTU/hr	18,000 BTU/hr	21,000 BTU/hr

The surface burners are rated at different power levels:

When you are using the surface burners, select the burner power and location depending on the heating or cooking function you would like to perform.

A normal flame is blue in color and steady. Foreign materials in the kitchen air or the gas line, especially in new construction installations, may cause some orange color bursts during initial operation. This will disappear with continued use. Small yellow tips on the ends of flames are normal when using LP gas.

If the flames look odd, (too small, too large, lazy or drifting, uneven around the burner circle, etc.), check to see that the burner head is seated correctly on the burner base. Do this when the burner is cold by gently rocking the burner head or rotating the head from side to side. If it is correctly seated, it will nest in detents, in the case of the sealed burners, or on the corresponding pin/hole for open burners. If this does not correct the problem, turn to the Troubleshooting section of this manual.

## AUTO RE-IGNITION

The surface burners are equipped with a special ignition and re-ignition system that senses the presence of flame and re-ignites the burner should the flame disappear while gas is still flowing to the burner.

Strong drafts, spills and general grime influence the operation of the automatic re-ignition system – a clean system will generally function better than a dirty system. Periodically, remove any materials or grime that might build up on the high voltage spark electrode – using a toothbrush or other non-metallic cleaning utensil.

# OPERATING YOUR RANGE

## COOKWARE RECOMMENDATIONS

To avoid the risk of serious injury, damage to the range or cookware, please observe the following guidelines.

Bakeware, such as large casserole pans, cookie sheets, etc., should never be used on the cooktop.

Placement of large stock pots should be staggered when used on the cooktop.

Select the base diameter of the pot to match the diameter of the flame. The diameter of the flame and the diameter of the pan bottom should match or be slightly smaller. Too large or too small pots on a burner will compromise cooking performance.

Do not place food packaged or wrapped in aluminum foil directly on the burner grate above the burner. Aluminum foil can melt during cooking.

Be careful to not let plastic, paper or cloth come in contact with a hot burner grate. These materials can catch fire or melt.

Never let a pan boil dry – and if it occurs remember it can be extremely hot – and very dangerous. If this should occur, turn off the burner immediately. Wait a while, until the pot cools down enough to handle – this could be several minutes, but could save you from burns or other serious injury.

The pan bottom should be flat, the heavier the better – and well balanced on the cooktop grate – sitting flat without rocking – preferably with tight fitting lids. Try not to slide the pot across the grates – while it is very handy to do so – you may end up scratching the pot or the grate.

Always be careful when using high flames, as in wok cooking, as they may contact flammable materials or make the handles of the wok very hot. Use the wok ring (optional) to stabilize the wok.

SUGGESTED BURNER SETTINGS	
HEAT SETTINGS	USE
Simmer	Melting small quantities of butter, simmer grains, rice, oatmeal
Low	Poaching eggs, fish, poultry
Low to Medium	Fry eggs, heat milk, cream sauces
Medium	Puddings, custards, gravies
Medium to High	Sauté vegetables, braise meats, soups and stews, deep fat frying, boiling water and pasta, blanching vegetables, searing meats
High	Large quantity of water to boil, large quantity frying and cooking

## CARE AND CLEANING

It is always easier to clean as you go – and while some evenings you'd rather sit down with a good book instead of a Scrubby, keeping your range cooktop and oven in a ready to go state for the next meal makes everything a little more tolerable.

When cleaning the range:

- » Use the mildest procedure that will do the job efficiently and effectively – and since some cleaners are harsher than others, it is best to try them on a small, inconspicuous area first.
- » Use only clean, soft cloths, sponges, paper towels, plastic brushes, non-metal soap pads for cleaning and scouring.
- » When cleaning the oven door, control panel, top curved section (called the bull nose) or the flat top area – always pretend it is made of wood – and rub the finish in the direction of the grain. This is the most effective cleaning direction, to prevent marring the surface.
- » Any part of this appliance can be cleaned with hot, sudsy water. When rinsing is required, rinse thoroughly.
- » Always wipe dry immediately to reduce the appearance of water marks.

## TO CLEAN THE COOKTOP

The cooktop is constructed from brushed stainless steel with brass burner heads. The burner cap, grates and optional wok ring are steel coated with porcelain.

- » Do not use abrasives on stainless steel. Use towels, sponges or soft plastic scrubbers. RUB ONLY WITH THE "GRAIN."
- » Do not use steel wool pads or green rough Scrubby's.
- » Wash all cooking surfaces with hot water and dish detergent such as Simple Green, Ivory Liquid, or Joy.
- » Rub stubborn spots with baking soda or liquid cleaner such as Windex All Surface Cleaner or 409.
- » Grates and burner caps can be soaked in hot soapy water. Mild scouring cleaners can be used, such as Bon Ami or Cameo on grates and burner caps.

Do not soak the knobs in water or put them in the dishwasher

- » Prior to cleaning, ensure knobs are in the off position.
- » Grasp each knob and pull up to remove.
- » Wash the knob with soft lint-free cloth or non-abrasive pad and a solution of warm water and mild dish detergent.
- » To reinstall the knobs, align the flat of the "D-shaped" opening of each knob with the end of its respective burner and knob valve shaft, and carefully push the knob on until it stops. (Reference burner and knob identification page)

## COOKTOP-BURNER OPERATION (Sealed and Open Burners)

Make sure there is nothing on the burners and/or grates prior to igniting the burners. Push the knob in, and turn it counter-clockwise to the HIGH position. Adjust the flame to the desired height. The burners are equipped with a flame-sensing ignition system that automatically detects the presence of flame on the burners, and relights in the event the flame goes out.

## CARE AND CLEANING RECOMMENDATIONS

PART / MATERIAL	CLEANING SUGGESTIONS	BEING CAREFUL
Main Top/ Porcelain Enamel	Soft Scrub may be used here. With a cool or slightly warm surface, use a damp sponge or cloth as recommended by the manufacturer.	Since the surface is glass (it can be scratched by certain materials) try to rub gently in small circles to allow time and chemical reactions to take place.
Control Knobs/ Powder Paint	Use dry hands to pull off the knobs; hot sudsy water works best here...	...with a sponge to avoid scratching
Chrome Knob Bezels	Hot soapy water works well here, with a sponge or soft cloth.	As with any round feature that meets the stainless steel grain, be careful to clean the bezels in a circular motion – and not contact the stainless steel control panel.
Exterior Finish Island Trim	Use hot soapy water; Fantastic, Formula 409, rinse and dry immediately. For hard water spots, try household vinegar or CLR. If there is any heat discoloration, consider using Zud, Wright's All Purpose Polish or Blue Away.	Rub lightly in the direction of the grain of the stainless steel. Salt (sodium chloride), chlorine or chlorine compounds in some cleaners are corrosive to stainless steel.
Grates/Porcelain Enamel on Cast Iron	Hot water and detergent with scrubby, or soap filled steel wool pad for really tough stains will work.	Remove sugar or acid based spills, they tend to attack the enamel. Remember the grates are heavy, use care when lifting and replacing.

## TROUBLESHOOTING

PROBLEM	POSSIBLE CAUSE	WHAT TO DO
Nothing Works	Cooktop may not be connected to electrical power Power to electrical outlet is off Power outage	Check to make sure the power cord is connected to the outlet Turn on the power at the circuit breaker or fuse box; check for a tripped breaker or blown fuse
Cooktop Will Not Heat	No electrical power to the cooktop Gas is turned off Gas supply has been interrupted	Check the circuit breakers in house Make sure the gas supply valve is in the "on" position Contact the gas company
Ignitors Keep Clicking	Reverse polarity of the electrical supply line Poor electrical ground  Dirty ignitor	Check the polarity with a hand-held tester Be sure the power cord has three prongs and plugs directly into the power receptacle (no adapter) Clean ignitors with a brush and rubbing alcohol
Ignitors Do Not Spark	Power not supplied to the unit Wet or dirty igniter	See NOTHING WORKS above Clean and dry the ignitor and burner assembly according to CARE and CLEANING section
No Flame	Ignitor not working (no clicking sound) Wet or dirty ignitor Gas is turned off Gas supply interrupted	See IGNITERS DO NOT SPARK above Clean and dry according to CARE and CLEANING section Make sure the gas supply valve is in the "on" position Contact your local gas company
Burner Goes Out At Low Setting	Low gas pressure	Contact your local gas company to have the gas pressure tested
Flame Is Distorted (Yellow Or Very Large)	Burner parts are dirty or clogged Burner parts are not properly assembled or positioned  Cooktop is set up to use a different type of gas (natural gas or liquid propane), or set up for a different altitude Gas regulator is not installed or faulty	Clean and dry according to CARE and CLEANING section Make sure the burner is assembled according to the SETTING UP YOUR COOKTOP section Have a qualified service technician check to make sure the cooktop is set up for the type of gas and the correct altitude Have a qualified service technician check the gas regulator
Ignitor Continues To Spark (Click) After Flame Ignites	Burner is cold  Flame is distorted by air draft  Wet or dirty ignitor Burner parts are wet or dirty Burners parts are not properly assembled or positioned  Power supply polarity is reversed	Burners may continue to spark for up to 60 seconds when cold and set to low. See OPERATING YOUR COOKTOP section for more information on how to minimize Minimize any air drafts around the cooktop. Close nearby windows Clean and dry according to the CARE and CLEANING section Clean and dry according to the CARE and CLEANING section Make sure burner is assembled according to the SETTING UP YOUR COOKTOP section Have a licensed electrician check the electrical outlet

# WARRANTY

American Range (hereafter AMR) hereby provides the following warranty to the original residential user ("Owner") for its new RESIDENTIAL Product(s) to be free from defects in material and workmanship in normal household use for the Warranty period(s) set forth below, beginning from the date that power and/or gas is turned on with proof of installation.

Without proof of installation, the beginning is from time of purchase under the terms and conditions as follows: Proof of original purchase date is required to obtain service under this limited warranty.

**This Warranty is applicable only on new AMR residential Products and is non-transferable.**

This Warranty is not applicable to AMR commercial Products. This Warranty is strictly limited to Products sold to the original Owner in the United States or Canada, and said Owner shall not be entitled to transfer this Warranty to third parties. This Warranty is also not applicable on AMR residential Products that are used for commercial purposes, including without limitation, vacation rentals, fire stations, clubs, government facilities, non-profit groups, bed and breakfast facilities, and board and care facilities, and any home based business whereby AMR products are utilized for a commercial, non-household purpose. Residential products should not be used in a commercial environment.

**Warranty Period:** For all Product(s) properly registered with AMR, with proof of purchase and within ninety (90) days from the date of purchase, a two year warranty\* is in effect subject to the terms and conditions herein. However, in the event that Owner fails to promptly register the Product(s) with AMR within ninety (90) days of the date of purchase, the Warranty period shall be strictly limited to a period of one year for parts and labor, from the date of purchase. Proof of purchase is required for all claims under this Warranty.

\*Igniters limited to a one year warranty, from the date of purchase. Proof of purchase is required for all claims under this Warranty. Two Year Warranty applies only to purchases made after May 1, 2018, with a serial number of 180101-100 or higher.

**Exceptions to the Warranty:** Rubber seals, light bulbs, and gaskets are covered for a period of ninety (90) days only. Oven glass, porcelain, and Products that are not defective, but that require adjustments for normal wear and tear are expressly excluded from this Warranty.

**Warranty Claims:** In the event of a claim for repair of the Product(s), and to obtain warranty service, Owner must contact either (i) the dealer from whom the product was purchased; (ii) an authorized AMR service agent; or (iii) AMR Residential service support at 1-888-753-9898. You will be asked to provide a model and serial number, and date of original purchase.

AMR shall provide all new replacement parts and all repair labor under the Warranty.

Under the terms of this Warranty, service must be performed by a factory authorized AMR service agent/representative, and approved in advance by AMR. AMR shall not be responsible for labor costs that have not been pre-approved, with written confirmation by AMR. Note that service providers are independent entities and not affiliated with AMR. Travel expenses from the factory authorized service agent to the product location are limited to 25 miles each way. For greater distances, either have the product delivered to the servicer, make separate travel arrangements, or pay for the additional servicer travel. All repair services shall be provided during normal business hours. AMR will not be responsible for premium time or overtime charges for labor covered under this warranty or for repairs made without AMR authorization. Such charges shall be the responsibility of the Owner.

**Limitation of Warranty:** AMR shall have no obligation under this Warranty as to any Product(s) which have been misapplied, mishandled, abused, misused, modified, altered, subject to improper cleaning methods, subject to harsh chemical action, modified by unauthorized service personnel, damaged by accidents, flood, fire, smoke, public unrest, earthquake, tornado, hurricane, other acts of God, Owner negligence,

reasons beyond the control of AMR, failures due to improper installation, insufficient gas or electrical supply, problems due to improper ventilation, or removed/altered serial numbers. Any damage due to water, chemical, or direct contact to infrared burners will also not be covered under this Warranty. This Warranty shall be void if the Product(s) are not properly installed by a licensed plumber, and not properly calibrated for electrical and gas connectivity, gas line size, correct pressure, and properly leveled. Additionally, AMR factory recommended cleaning instructions must be followed by Owner at all times or this Warranty shall be voided by AMR. All delivery, installation, labor costs and other service costs are the responsibility of the purchaser.

Dealer display, model home display and products sold "as-is" have the following warranty:

1. One (1) year parts only warranty, if the manufacture date is less than three (3) years old.
2. Excludes items that are: missing; cracked; aesthetic; broken; dented; frayed.

**Accordingly, except as stated herein-above the dealer display and model home display goods are being sold on an "as-is" or "with all faults" basis. Except as stated, the entire risk as to the quality and performance of the goods is with the buyer. Additionally, except as stated, should the goods prove defective following their purchase, the buyer and not the manufacturer, distributor, or retailer assumes the entire cost of all necessary servicing or repair.**

THIS WARRANTY IS LIMITED AND MADE IN LIEU OF ANY AND ALL OTHER SUCH WARRANTIES EXPRESSED OR IMPLIED, INCLUDING WITHOUT LIMITATION, ANY IMPLIED WARRANTY OF MERCHANTABILITY OR FITNESS FOR A PARTICULAR PURPOSE. THE ENTIRE LIABILITY OF AMR IS SET FORTH HEREIN THIS WARRANTY. OWNER SPECIFICALLY UNDERSTANDS AND ACKNOWLEDGES THAT THERE ARE NO WARRANTIES, EITHER EXPRESSED OR IMPLIED HEREUNDER OTHER THAN THE WARRANTIES WHICH ARE SPECIFICALLY STATED HEREIN. SAID OWNER SHALL NOT RELY ON ANY OTHER ASSERTIONS, REPRESENTATIONS OR STATEMENTS BY AMR OR ITS AGENTS, OTHER THAN THOSE SPECIFICALLY EXPRESSED IN THIS WARRANTY.

AMR'S LIABILITY ON ANY CLAIM OF ANY KIND IS EXPRESSLY LIMITED AND SHALL NOT EXCEED THE WHOLESALE PRICE OF THE PRODUCT(S) OR PART(S) THEREOF THAT GIVE RISE TO SUCH CLAIM.

Failure by AMR to enforce any of its rights under this Warranty shall not be construed as a waiver of those rights. AMR specifically reserves the right to investigate and verify all claims to determine the validity of the claim and the claimant's qualifications under this Warranty. AMR reserves the right to refuse Warranty service in the event that AMR determines that a claimant's right to the Warranty is inapplicable under the terms and conditions herein.

AMR is not responsible for consequential or incidental damage whether arising out of breach of warranty, breach of contract, tort, or any other legal theory, including without limitation, property damage, bodily injury, loss of use, and/or lost profits. This Warranty gives the Customer certain legal rights. The customer may also have other legal rights which vary from state to state. Some states do not allow limitations on how long an implied warranty lasts, or do not allow the exclusion or limitation of incidental or consequential damages. If such laws apply, the limitations or exclusions contained in the terms and conditions of this Warranty may not apply to all such Owners.

AMR expressly reserves the right to make changes to their Warranty policy before or after purchase by the Owner.

# AMERICAN RANGE

QUALITY PROFESSIONAL COOKING EQUIPMENT

## WARRANTY REQUIREMENT

For reliable operation and for your own safety, this professional cooking equipment must be installed by a certified/licensed contractor.

Failure to comply will void any written or implied warranty.

In the event the equipment requires service during the standard warranty period, the receipt proving certified installation must be made available to American Range for verification.

If installation was not performed by a certified/licensed contractor, be prepared to submit a major credit card for payment for proper installation prior to service.

## NOTES

---

---

---

---

---

---

---

---

---

---

---

---

---

---

---

---

---

---

---

---

---

---

---